

Talyrond® 565/585XL

High precision measurement of large diameter components



The Talyrond 500XL

High Precision Instruments for Large Diameter Components

The Talyrond 500XL with frictionless air bearing spindle and adjustable column is the ideal system for measurement of large diameter components







Measurement of parts up to 1 metre diameter

Extremely popular in the measurement of large diameter bearings and non-rotationally symmetric components. These instruments are based around the successful Talyrond 500 range, the precision spindle with adjustable column enable measurement of parts up to 1 metre in diameter.

Reproducible measurement results

Decades of experience, ultra precision machining expertise and FEA optimized design combine to provide low noise and near flawless mechanical execution of the measuring axes. Further enhancement via the use of traceable standards and exclusive algorithms effectively eliminates instrument influence from the measurement results.

Monitoring manufacturing

 Gauge	 Roundness	 Roughness	 Contour
Gauge Range Up to 4 mm	Radial Accuracy $\pm 0.01\mu\text{m}$	Noise Less than 30nm Rq all axes	LS Arc measurement 5 μm
Resolution Down to 0.3 nm		Ra values Less than 0.1 μm	Pt 0.5 μm

Unparalleled measurement capability

Five measurements in one

Emulating the manufacturing process with a higher degree of precision allows all features to be measured on one instrument

1

Roughness

High resolution gauge and low axis noise enables linear or circumferential surface roughness measurement.

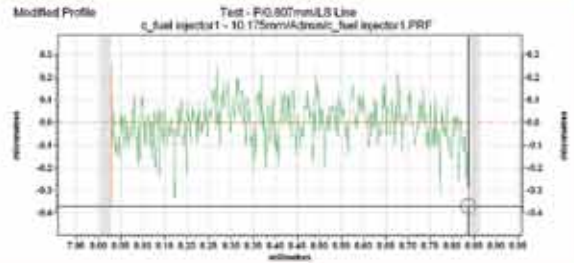

2

Roundness

Frictionless air bearing spindle and precision column for roundness, cylindricity and straightness measurements.

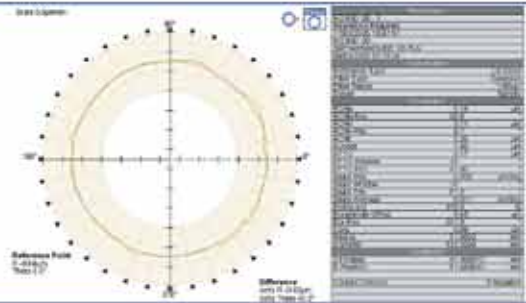

3

Contour

Our patented calibration technique enables measurement of radius, angle, height, length, distance and more.

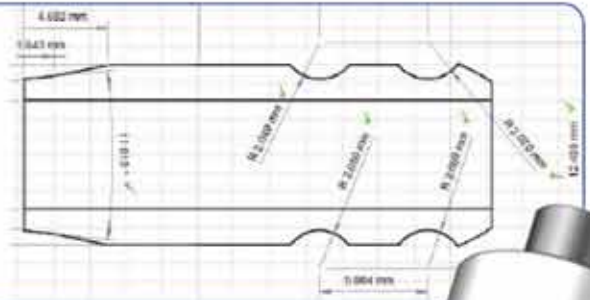

4

Cylindrical mapping

Precision control and low noise in all axes allows in depth analysis of cylindrical components including wear scars and material volume.



5

Cams and pistons

A precision encoder and linear scales in all axes enables measurement of non round parts such as cams and pistons.

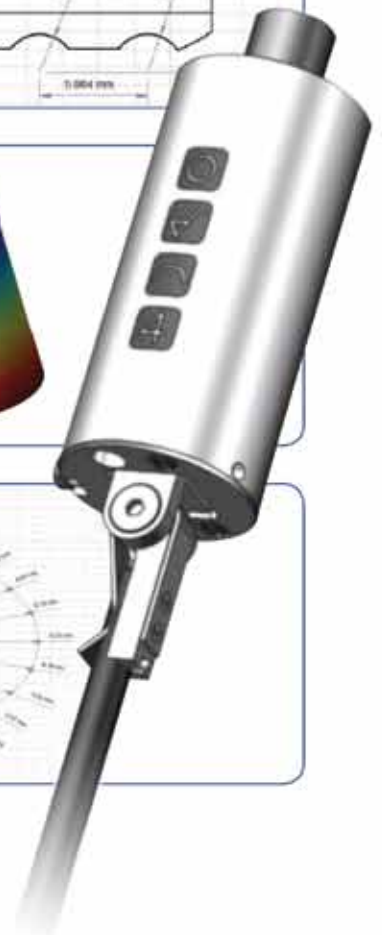
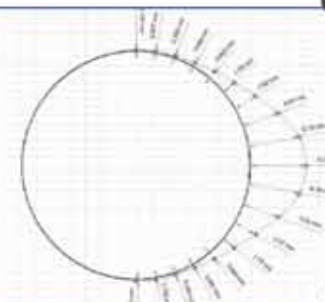

Powerful software tools help improve your process

Advanced harmonics – identify the cause of bad parts

Ordinary inspection might detect bad components but Talyrond 500XL can help you fix the production issues that are causing them. Deviation in form on a workpiece can be broken down into irregularities that have both frequency and amplitude. Harmonic analysis identifies these imperfections allowing you to pinpoint and correct their cause, reducing the need for ever tighter tolerances on size.

- Full histogram view with tolerance bands
- Pass/Fail and warning messages
- Ranking system according to wave depth or harmonic amplitude
- Comparison to CSV or GKD files
- Up to 5000 upr
- Wave depth or harmonic amplitude format

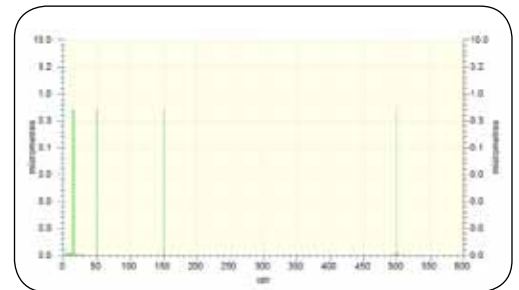
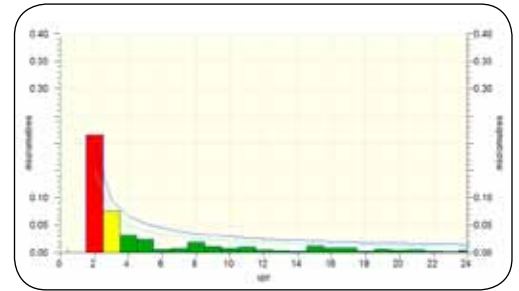
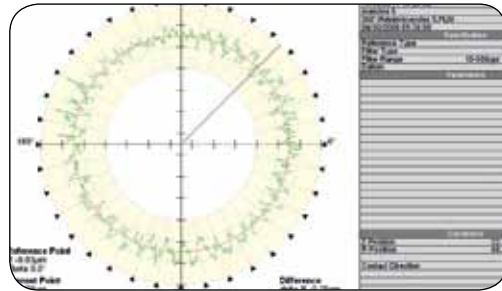

Precision harmonic standard

A precision machined standard with the following undulations in 360 degrees:

15	upr
50	upr
150	upr
500	upr
1500	upr



“Giving confidence in your instrument.”

3D cylindrical mapping

For production issues beyond the scope of traditional 2D inspection techniques

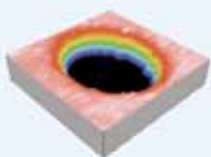

Crankshaft oil hole without washout

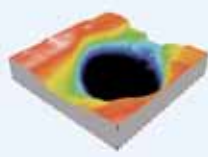

Crankshaft oil hole with washout

With high accuracy and high resolution in all axes, Talyrond 500XL allows you to measure in 3 dimensions for more thorough examination of flaws, defects and cutting tool geometry effects that influence performance or lead to component malfunction.

- Twist or lead detection
- Machining defects
- Wear scar analysis
- Leak detection and more

Q-Link Production Interface

A simplified interface designed specifically for production environments

- Q-DAS accredited
- Compatible with all instruments
- Simple operation
- User levels
- Traceable fields
- Simple tolerancing
- Automatic summary reports
- Automatic statistical studies



Applications

Inner bearing races

Harmonic analysis

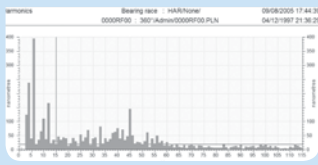

Form & radius analysis

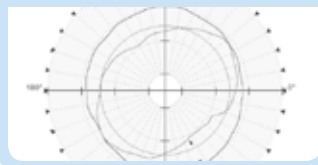

Roundness

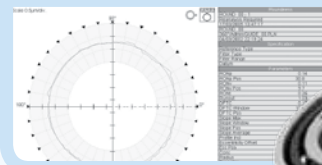

Roller bearings

Roundness

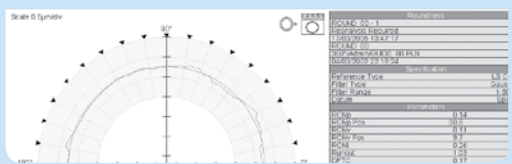

Harmonic analysis

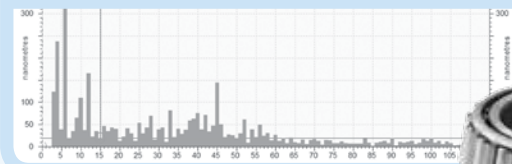

Jet engines

Roundness

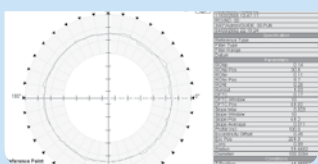

Parallelism

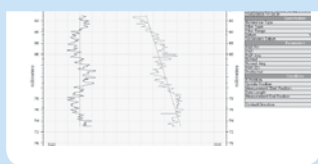

Surface finish

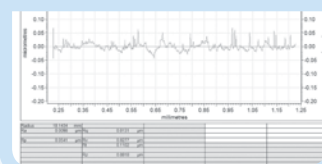

Crankshafts

Parallelism

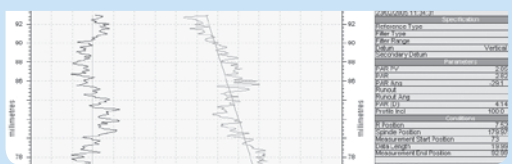

Cylindricity

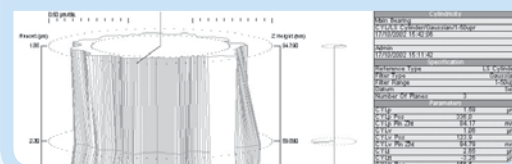

Cylinder heads and blocks

Surface finish

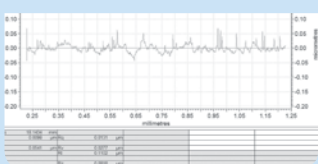

Parallelism

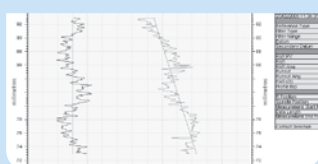

Cylindricity

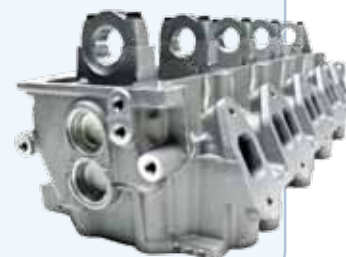
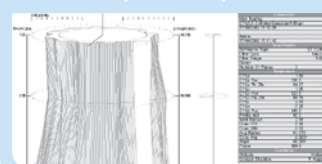



Non-symmetrical powertrain components



Large diameter high precision bearings



Small jet and turbine engine components

Measurement of non-symmetrical power train components

The majority of power train components are non-symmetrical by nature making them difficult or impossible to measure on traditional roundness systems. The XL range of instruments have been designed to accept wide swing capacities and are ideal for components such as connecting rods, small engine blocks and heads.

As well as non-symmetrical components these roundness systems can measure crankshafts, pistons, valves and cylinder liners making it the most versatile roundness system on the market.

Measurement of large diameter high precision bearings

The Talyrond 565 and 585XL systems come with a frictionless air bearing spindle with high load capacity and excellent spindle stiffness. Large diameter bearings can be measured to a high degree of accuracy and with a high degree of resolution thanks to the massive 72,000 data point resolution of the systems high precision encoder. Added to the system's roundness/flatness capability each XL instrument comes with Harmonic and Velocity analysis software making it a powerful tool for the analysis of bearing surfaces.

Measurement of small jet engine and turbine components

Whether a supplier of engine components or a maintenance, repair and overhaul facility the XL range can help to control engine efficiency and improve engine build time by the analysis of roundness, flatness and form. Parameters such as eccentricity and run-out added to their angular direction allow prediction and control of out of balance situations particularly on stacked components. Features such as harmonic analysis and velocity analysis provide further information to aid in prediction of vibration and noise.

Industries and applications:

- Automotive
- Aerospace
- Bearings
- Hydraulics
- Optics
- Industrial plants

“Having the responsibility to ensure 1.5 million bearings each year are manufactured to the highest quality, means controlling our components at all stages of manufacturing. We have 15 Taylor Hobson roundness measuring instruments that help us maintain high throughput and the accuracies we require to ensure every one of our bearings is of the highest quality.”

Measurement Q/A Coordinator – Leading global bearings manufacturer



Designed for metrology without compromise

The construction of the 500XL series range is key to measurement integrity

Reproducing the part

Taylor Hobson's core competencies are in cylindrical grinding, surface grinding and diamond turning. All of these disciplines coupled with knowledge in drive mechanisms go towards constructing an instrument with low noise and high geometric accuracy, ensuring reproducibility of the component.

Frictionless air bearing spindle

The instrument's spindle axis, like any spindle based machine tool, is paramount in ensuring integrity of measurement. Utilising Taylor Hobson's own diamond turning lathe we are able to create a reference datum unsurpassed in accuracy and reliability.

Instrument base

Using finite element analysis software, the instrument base provides a solid foundation for both the high precision air bearing spindle and vertical straightness datum, ensuring movement and weight do not affect results. The 500XL is equally at home in inspection laboratories or production environments.

Straightness datums

The vertical column is machined for straightness, waviness and roughness to an exacting standard, using traceable standards and techniques developed by Taylor Hobson. The straightness datums are further enhanced to ensure reproducibility of the part with little or no instrument influence.

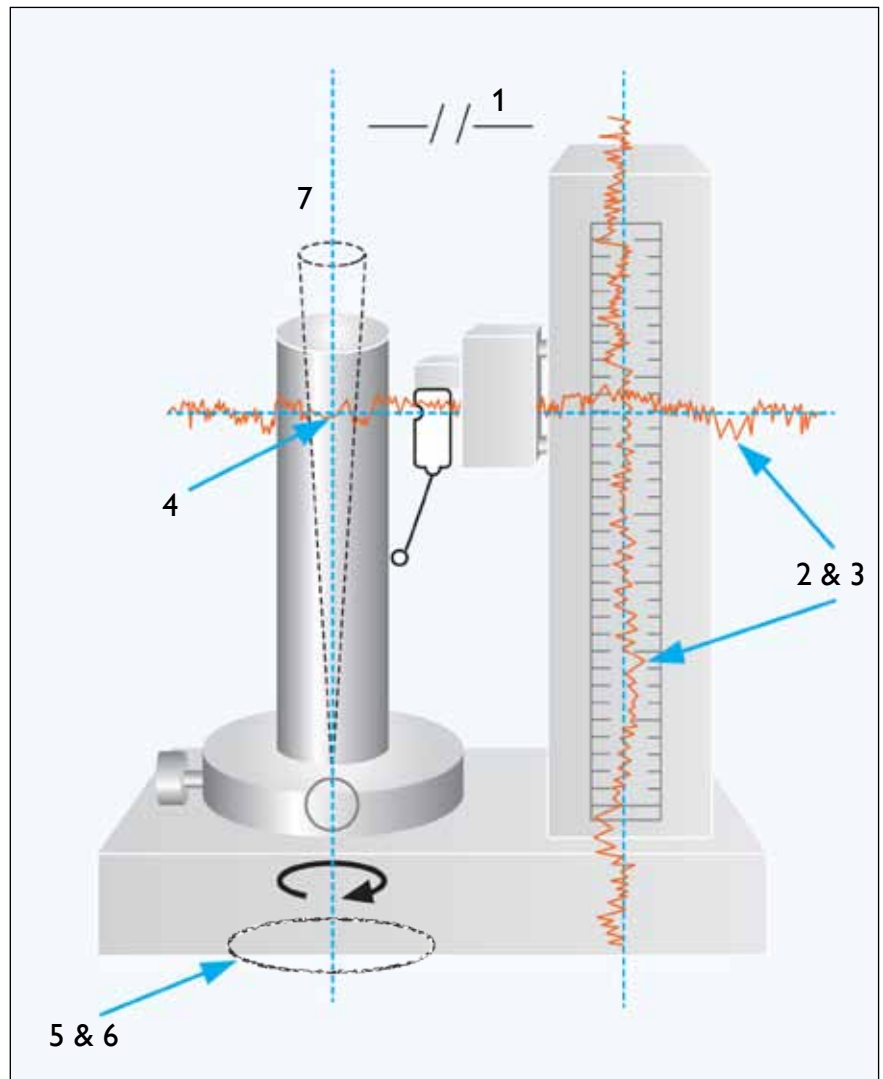

Important features of a roundness system

- 1 Parallelism of column to spindle axis
- 2 Column and arm straightness
- 3 Low vertical and radial arm noise
- 4 Squareness of arm to spindle axis
- 5 Radial run-out of spindle
- 6 Low spindle noise
- 7 Minimized coning error of spindle
- 8 Accurate glass scales in all axes

“World-beating
noise floor”

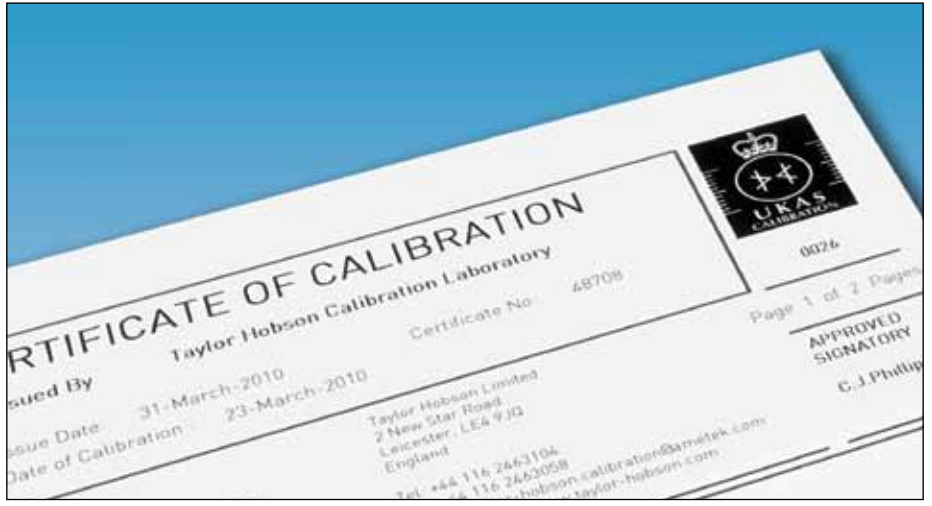

Traceability

Full traceability to international standards

Traceability

All calibration standards can be provided with traceability to international standards using Taylor Hobson's own UKAS laboratory.

Arcuate correction (contour option)

Taylor Hobson's patented calibration routine and calibration ball corrects for the arcuate motion of the stylus allowing dimensional measurement. This routine is critical to measurement of radius and angled parts when normal calibration routines will not suffice.



Roundness

Using a precision polished glass hemisphere calibrated to an uncertainty of less than 5nm Taylor Hobson can guarantee your spindle is within specification and maintain quality of results.

Gain correction

The TR500 series has a unique automated gain calibration for the instrument's gauge; the routine is automated and takes a matter of seconds to set. Alternatively a set of calibrated slip blocks traceable to primary standards are also supplied.

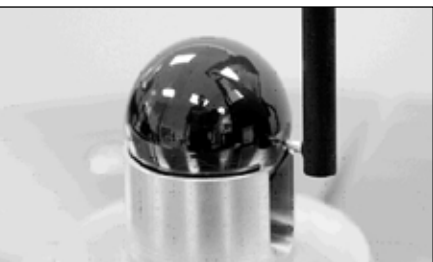

Straightness, squareness and parallelism

To ensure the column and radial straightness unit conform to specification we can provide standards that are either cylindrical or flat. These standards provide certainty of the measurement axes. These artefacts are combined with special software routines to enhance all axes for correct geometrical form.

Axis calibration

Automated or manual routines can be supplied allowing the user to set coordinates to the part or instrument axes. The optional fully automated routine calibrates the arm, column and spindle.

Surface finish

A unique standard is available that provides measurement traceability for roughness in both a vertical and circumferential direction.

Industry specific software

Velocity analysis allows bearing manufacturers to evaluate harmonics with respect to amplitude and predict function with respect to speed.



Accessories

All the accessories you need to begin using Taylor Hobson roundness measuring systems are supplied as standard. However, for more demanding requirements or improved measurement throughput, we have a range of accessories which may be ordered separately.

① Talyrond ball calibration standard

Required for use with contour or form software, this calibration standard corrects for gain, tip and arcuate motion of the stylus

Talyrond ball standard rad 7.5mm
(Not recommended for 4 mm range)

code 112-4305UC

Talyrond ball standard rad 12.5mm
(Not recommended for 4 mm range)

code 112-4319UC

Talyrond ball standard rad 22.5mm

code 112-4092UC

② Calibration standard for vertical and circumferential roughness

code 112/4341 UCR

③ Six jaw component chuck

A 6 jaw precision scroll chuck.

Capacity - Inside diameter
20 mm - 95 mm (0.78 in - 3.74 in).

Capacity - Outside diameter
2 mm - 32 mm (0.08 in - 1.26 in).

code 112/1859 optional

④ Standard stylus arms

Ruby ball x 100 mm (3.9 in)

1 mm (0.039 in), **code 112/3245**

2 mm (0.078 in), **code 112/3244**

4 mm (0.157 in), **code 112/3243**

⑤ Precision collet chuck - removable three ball type location (for use with manual or automated tables)

Note: Collet required – see list below.

code 112/3662

code 112/3554-1.0 1 mm Collet

code 112/3554-1.5 1.5 mm Collet

code 112/3554-2.0 2 mm Collet

code 112/3554-2.5 2.5 mm Collet

code 112/3554-3.0 3 mm Collet

code 112/3554-3.5 3.5 mm Collet

code 112/3554-4.0 4 mm Collet

code 112/3554-4.5 4.5 mm Collet

code 112/3554-5.0 5 mm Collet

code 112/3554-5.5 5.5 mm Collet

code 112/3554-6.0 6 mm Collet

code 112/3554-6.5 6.5 mm Collet

code 112/3554-7.0 7 mm Collet

code 112/3554-7.5 7.5 mm Collet

code 112/3554-8.0 8 mm Collet

code 112/3555 Adjustable End Stop

Recommended for use with 112/3549 or 112/3662; may require modification to suit the component under test.

Bar stylus

A 100mm (3.9in) stylus for measuring small diameter components.

code 112/3489 optional

Diamond styli

Conisphere stylus with 90° included angle; required for cylindrical mapping or surface finish applications.

code 112/3806 optional 5 µm Rad

code 112/3807 optional 10 µm Rad

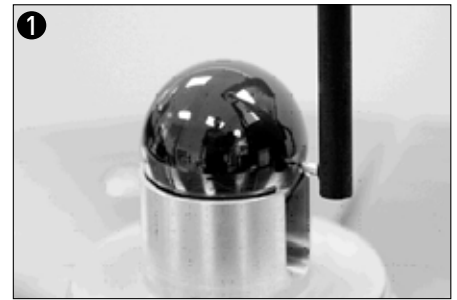

Kinematic dowel support set

For stable workpiece mounting.

code 112/1861 standard

Reservoir assembly kit

If the air supply is unreliable or of poor quality then the reservoir assembly is recommended to provide an even flow of air to the spindle.

code 112/2869 optional

Force setting gauge

Recommended with diamond styli and where specific stylus forces are required.
code 112/3808 optional

6 High precision glass hemisphere

For checking total system performance; UKAS calibration certificate is optional.
Roundness < 0.02 μm (0.8 μm)
code 112/2324 optional

Glass hemisphere

For checking total system performance; UKAS calibration certificate is optional.
Roundness < 0.05 μm (2 μm)
code 112/436 optional

7 High precision test cylinder

For verification of the instrument's vertical straightness accuracy and parallelism of the vertical axis to the spindle axis. UKAS calibration certificate is optional.
code 112/3670-01 optional

Precision test cylinder

For checking the instrument's vertical straightness accuracy and parallelism of the vertical axis to the spindle axis. UKAS calibration certificate is optional.

300 mm (11.8") cylinder
Roundness < 0.25 μm (10 μm)
Straightness < 0.5 μm (20 μm)*
code 112/1888 optional

500 mm (19.7") cylinder
Roundness < 0.25 μm (10 μm)
Straightness < 0.5 μm (20 μm)*
code 112/1997 optional

1000 mm (39.4") cylinder
Roundness < 0.75 μm (30 μm)
Straightness < 3 μm (120 μm)*
code 112/3604 optional

* Straightness over central 90% of test cylinder length

8 Cresting standard

For checking the vertical and horizontal alignment of the gauge head.
code 112/1876 optional

9 Flick standard

For rapid calibration of the gauge head; alternative to the standard gauge calibration set.
20 μm (788 μm) range
code 112/2308 Optional
300 μm (0.012") range
code 112/2233 optional

10 Calibration set

For calibrating the gauge head. The set comprises a circular glass flat and four gauge blocks. UKAS calibration certificate is optional.
code 112/2889 standard

Glass flat 250 mm (10") diameter
For checking the straightness and alignment of the horizontal arm with respect to the spindle axis.
code 112/1998 optional

Instrument cover

To protect the instrument when not in use.
code 112/1393 optional

ECU Fuse kit

code 112/4234 optional

Pre-filter element

code 112/3351 optional

Accessory case

A useful case for carrying standard and optional accessories.
code 48/453 optional

Set of hexagonal wrench keys

To assist with minor adjustments on the instrument.
code 630/412 optional

Coalescing filter element

Secondary filter to be changed every 3 months to maintain a clear air supply, (1 included with the instrument).
code 112/3378 optional



Customised solutions for special applications

Our strategy for success is simple, instead of just selling products, we provide solutions. If our standard instruments and accessories do not satisfy your needs, we can customise a solution to exactly match your application. This may include such things as work holding devices or special styli for applications such as small bores, shoulders or undercuts.

Specifications are subject to change without notice.

Talyrond 500XL specification

Analysis capability

Standard software		Optional software	Filters
Roundness	Parallellism	Piston measurement	Roundness
Squareness	Vertical straightness	Commutator analysis	
Concentricity	Partial arc flatness	Disk thickness variation	
Coaxiality	Partial arc roundness	Velocity analysis	
Slope	Cylindrical mapping	Wall thickness variation	Surface
Cylindricity	Departure from True Plane (DFTP)	Advanced harmonics	
Total run-out	Departure from True Circle (DFTC)	Groove analysis	
Flatness	Radial straightness (RSU)	Harmonics	
Eccentricity	Multiplane flatness (RSU)	TalyMap Contour Software	
Run-out	Multiplane roundness	TalyMap 3D analysis Software	
		Circumferential Surface finish analysis	
		Surface finish analysis	
		Twist analysis	<ul style="list-style-type: none"> • Gaussian • Robust Gaussian • 2 CR Phase corrected • 2 CR

Measurement capability

Column axis	300 mm column	500 mm column	1000 mm column	1200 mm column
Straightness over column length	0.3 µm / 300 mm (11.8 µin / 11.8 in)	0.3 µm / 500 mm (11.8 µin / 19.7 in)	0.75 µm / 1000 mm (29.5 µin / 39.4 in)	1 µm / 1200 mm (39.4 µin / 47.2 in)
Straightness over any 100mm (3.94in)	0.15 µm / 100 mm (5.9 µin / 3.94 in)	0.15 µm / 100 mm (5.9 µin / 3.94 in)	0.3 µm / 100 mm (11.8 µin / 3.94 in)	0.3 µm / 100 mm (11.8 µin / 3.94 in)
Vertical axis to spindle axis parallelism**	0.5 µm / 300 mm (20 µin / 11.8 in)	0.75 µm / 500 mm (29.5 µin / 19.7 in)	1 µm / 1000 mm (39.4 µin / 39.4 in)	1.5 µm / 1200 mm (59 µin / 47.2 in)
Column noise †	<30 nm	<30 nm	TBA	TBA

Spindle axis	
Radial limit of error (at table height)	± 0.01 µm (1-15 upr) or ± 0.015 µm (1-50 upr)
Axial limit of error (at table center)	± 0.01 µm (1-15 upr) or ± 0.015 µm (1-50 upr)
Coning Error (height above table)	± 0.00025 µm/mm
Coning Error (radius from centre)	± 0.00025 µm/mm

Horizontal arm axis	Radial straightness unit	Motorized radial arm
Straightness over full length of travel	0.25 µm / 200 mm (10 µin / 7.9 in)	N/A
Straightness over any 50 mm	0.125 µm + 0.000625 µm/mm (5 µin + 0.025 µin/in)	N/A
Squareness to spindle axis	1 µm / 200 mm (39.4 µin / 7.9 in)	N/A
Radius measurement *	(0.1 µm/mm + 1.5 µm)	
Arm noise †	<30 nm Rq	N/A

Gauge	Range/resolution
High range	± 2 mm , 0.016 µm resolution (0.078 in range, 0.6 µin resolution)
Normal range	+/- 1 mm range, 0.008 µm resolution (0.039 in range, 0.3 µin resolution)
Mid range	+/- 0.2 mm range, 0.0016 µm resolution (0.0078 in range, 0.06 µin resolution)
Low range	+/- 0.04 mm range, 0.0003 µm resolution (0.003 in range, 0.012 µin resolution)

Component capacity

Measuring capacity	300 mm column	500 mm column	1000 mm column	1200 mm column
Maximum component height	300 mm (11.82 in)	500 mm (19.7 in)	1000 mm (39.4 in)	1200 mm (47.2 in)
Maximum component diameter	Home Position 560 mm (22 in) - Rear Position 1040 mm (40.9 in)			
Maximum bore measuring depth (with standard length stylus)	565XL 160 mm (6.3 in) or 585XL 155mm (6.1 in)			
Maximum measuring diameter	Home Position 520mm (20.5 in) - Rear Position 1000 mm (39.3 in)			
Maximum worktable loading	75kg (165 lb)			
Maximum worktable moment loading	Auto C&L: 1250 kg/mm (108 lb/in) within a central 80 mm (3.15 in) equilateral triangle			

† Vertical traverse measured with a 10 Kg load at 200 mm height; horizontal traverse measured with a 20 Kg load at 400 mm height. All measurements based on a nominally leveled glass flat using the specified stylus; analyzed using a Gaussian filter; 0.8 mm cut off, 300:1 bandwidth and parameter Rq.

* Based on measurements made within 2 mm radius of a calibrated ring or plug gauge

** Based on column in home position

Technical

Column axis	300 mm column	500 mm column	1000 mm column	1200 mm column
Column construction	Precision machined cast iron			
Movement range	300 mm (11.8 in)	500 mm (19.7 in)	1000 mm (39.4 in)	1200 mm (47.2 in)
Speed of traverse - moving	0.1-105 mm/sec (0.004 - 4.33 in/sec) stepped			
- measuring	0.1-20 mm/sec (0.004 - 0.8 in/sec) stepped			
- contacting	0.5-5 mm/sec (0.02 - 0.2 in/sec) stepped			
Positional control	4 µm			
Length measurement	(0.03 µm/mm + 1.5 µm)			
Positional resolution	0.25 µm (0.98 µin)			
Number of data points (selectable)	200,000			

Horizontal arm axis	Radial straightness unit	Motorized radial arm	
Arm construction	Lapped ceramic datum	Extruded aluminum datum	
Movement range	200 mm (7.9 in)	200 mm (7.9 in)	300 mm (11.8 in)
Speed of traverse - moving	0.25 - 15 mm/s (0.01 - 0.6 in/s) stepped		
- measuring	0.25 - 15 mm/s (0.01 - 0.6 in/s) stepped	N/A	
- contacting	0.5 - 5 mm/s (0.02 - 0.2 in/s) stepped		
Over-center travel	25 mm (0.98 in) in column home position		
Positional control	5 µm (200 µin)		
Positional resolution	0.25 µm (0.98 µin)		
Minimum movement	0.05 mm (0.002 in)		
Number of data points (selectable)	200,000		

Spindle axis	
Spindle construction	Precision air bearing
Speed of rotation	0.3 - 10 rpm
Positional control	± 0.2°
Positional resolution	0.02° (optional ± 0.005°)
Number of data points (selectable)	3600, 18,000 and 72,000

Centering and leveling table	Automatic
Achievable accuracy of auto centering	<0.8 µm (32 µin)
Achievable accuracy of auto leveling	<0.8 arc secs
Construction	Patented 3 point kinematic support
Center and leveling table control	Automatic with continuous spindle rotation
Follow mode center and leveling	Yes
Centering range	+/- 5 mm (0.2 in)
Leveling range	+/- 0.5 °
Worktable diameter	300 mm (11.8 in)

Gauge	
Gauge type	Talymin 6 single bias inductive transducer
Stylus tip force	0 to 4 g adjustable
Crutch angle	Adjustable (optional fixed)
Cresting (TR585)	Dual cresting facility (horizontal & vertical)

Gauge attitude/ orientation	565XL	585XL
Control	Manual	Automatic
Attitude	Horizontal and Vertical	
Attitude Vertical	Internal/External	
Attitude Horizontal	Up/Down Extend/Retract	
Orientation	Rotation in steps of 30 °	Rotation in steps of 1 °

All accuracies are quoted at 20° C ± 1° C (68° F ± 1.8° F). All roundness and flatness results are quoted as the departure from the Least Squares Circle (LSC) at 1 - 50 UPR, Gaussian filter; 6 RPM, clockwise rotation (unless otherwise specified). All errors are quoted as maximum permissible errors (MPE). All straightness / parallelism results are quoted with an 8 mm cut-off, low pass filter; 5mm/s measuring speed, Minimum Zone (MZ) reference. Quoted uncertainties are at 95% confidence in accordance with recommendations in the ISO Guide to the Expression of Uncertainty in Measurement (GUM: 1993).

Electrical (alternating supply, single phase with earth, 3-wire)	
Instrument & computer voltage	90V - 130V or 200V - 260V (switch selectable)
Frequency	47 Hz to 63 Hz
Power consumption	500VA maximum
Safety	BS EN 61010-1, BS EN 349, BS EN 13850, BS EN 983, BS EN 60204 Machinery Directive standards
EMC	BS EN 61000-6-1, BS EN 61000-6-3

Air supply	
Air pressure	550 to 1030 kPa (5.5 to 8 bar) (80 to 116 psi)
Regulator (pre-set)	350 kPa (3.5 bar) (50 psi)
Max. particle size	5 micron (0.0002 in)
Moisture content – dew point	+3 °C (37 °F)
Flow rate at operating pressure	150 litres/minute (minimum) 5.3 ft ³ /min
Max oil content	25 mg/m ³ (0.01 grains/ft ³)
Solid particle content	5 mg/m ³ (0.002 grains/ft ³)

Environment	
Operating temperature	10 °C to 35 °C (50 °F to 95 °F)
Storage temperature	-10 °C to 50 °C (14 °F to 122 °F)
Temperature gradient	< 2 °C / hour (< 3.6 °F / hour)
Operating humidity	30 % to 80 % relative humidity non condensing
Storage humidity	10 % to 90 % relative humidity non condensing
Maximum RMS vertical	0.05 mm/s (0.002 in/s) at < 50 Hz
Floor vibration	0.10 mm/s (0.004 in/s) at > 50 Hz

All measurements are taken using a standard 100 mm-length stylus with 2 mm-diameter ball tip. All measurements of roundness and flatness are quoted using the gauge horizontal orientation. All measurements of roundness are relative to the calibrated form of a glass hemisphere. Calibration error of glass hemisphere is ± 5nm.

The above quoted technical data is for measurements taken with good metrology practice in a draft free, controlled environment isolated from low frequency floor borne vibration (i.e., metrology laboratory or Taylor Hobson supplied environmental enclosure).

Talyrond 500XL floor plan

Front Elevation

Illustrating layout of main system dimensions.
Desk for location of PC, Monitor, etc not shown.

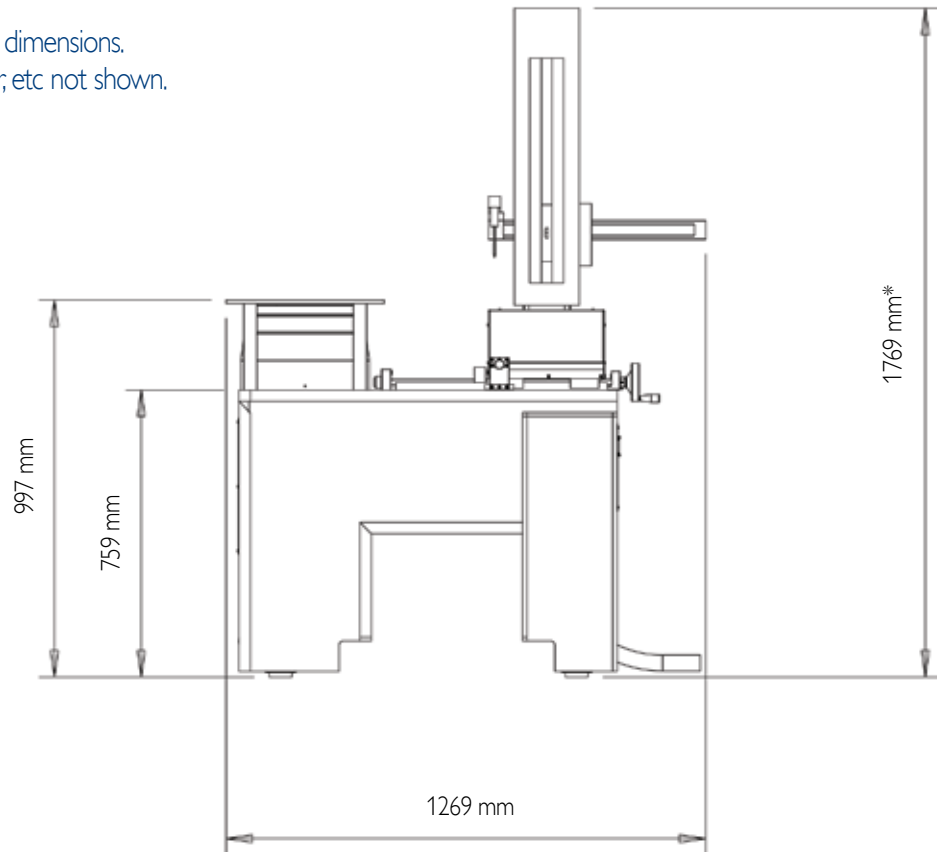

Side Elevation / Plan View

Illustrating layout of main system dimensions.
Desk for location of PC, Monitor, etc not shown.

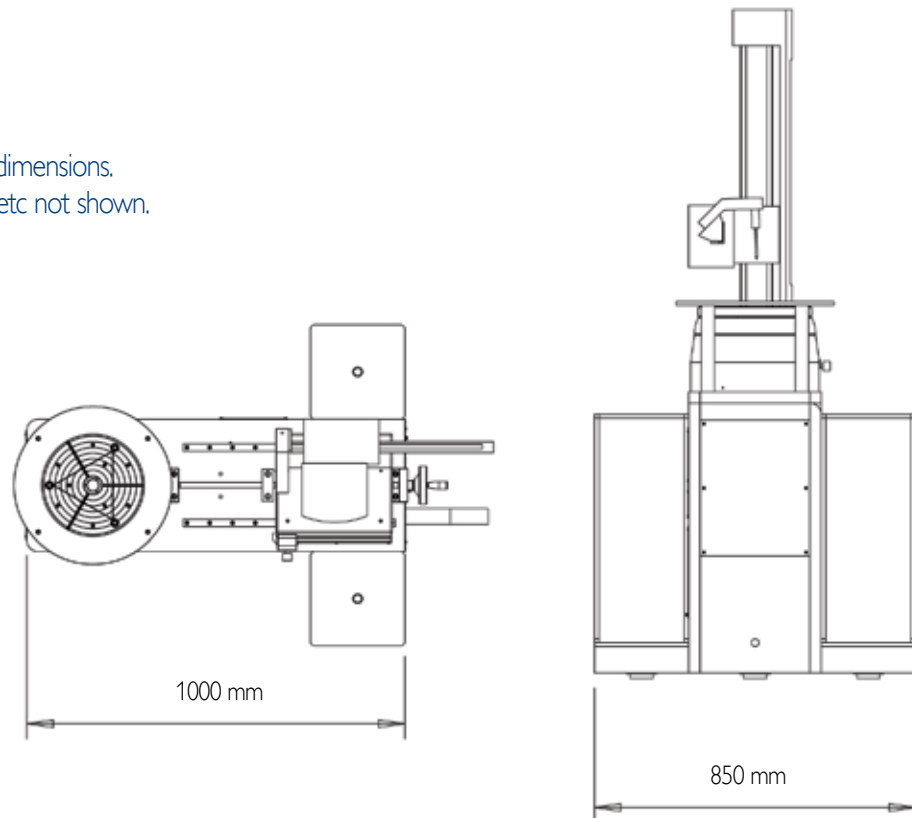

Taylor Hobson pursues a policy of continual improvements due to technological developments. We therefore reserve the right to deviate from catalog specifications.

* Based on 500mm column

Parameters

Type of analysis	Measurement mode	Evaluation diagram	Talyrond 500XL	Type of analysis	Measurement mode	Evaluation diagram	Talyrond 500XL
Roundness			✓	Radial Runout	Axial		✓
Parallelism			✓		Radial		✓
Cylindricity			✓	Squareness		✓	
Straightness			✓	Parallelism		✓	
Flatness			✓	Measure Interrupted Surface		✓	
Coaxiality			✓	Harmonic Analysis		●	
Concentricity			✓	Thickness Variation	Radial		●
Eccentricity			✓		Axial		●

✓ = Included – ● = Optional ✕ = Not available
(Customer specific analysis available on request)

Serving a global market

Taylor Hobson is world renowned as a manufacturer of precision measuring instruments used for inspection in research and production facilities. Our equipment performs at nanometric levels of resolution and accuracy.

To complement our precision manufacturing capability we also offer a host of metrology support services to provide our customers with complete solutions to their measuring needs and total confidence in their results.

Contracted services from Taylor Hobson

Sales department

Email: taylor-hobson.sales@ametek.com

Tel: +44 (0)116 246 2034

- **Design engineering**
special purpose, dedicated metrology systems for demanding applications
- **Precision manufacturing**
contract machining services for high precision applications and industries

Service department

Email: taylor-hobson.service@ametek.com

Tel: +44 (0)116 246 2900

- **Preventative maintenance**
protect your metrology investment with an Amecare support agreement

Centre of Excellence department

Email: taylor-hobson.cofe@ametek.com

Tel: +44 (0)116 276 3779

- **Inspection services**
measurement of your production parts by skilled technicians using industry leading instruments in accord with ISO standards
- **Metrology training**
practical, hands-on training courses for roundness and surface finish conducted by experienced metrologists
- **Operator training**
on-site instruction will lead to greater proficiency and higher productivity
- **UKAS calibration and testing**
certification for artifacts or instruments in our laboratory or at customer's site



0026

2624

Taylor Hobson UK

(Global Headquarters)

PO Box 36, 2 New Star Road
Leicester, LE4 9JQ, England

Tel: +44 (0)116 276 3771 Fax: +44 (0)116 246 0579
email: taylor-hobson.uk@ametek.com



Taylor Hobson France

Rond Point de l'Epine Champs
Batiment D, 78990 Elancourt, France

Tel: +33 130 68 89 30 Fax: +33 130 68 89 39
taylor-hobson.france@ametek.com



Taylor Hobson Germany

Postfach 4827, Kreuzberger Ring 6
65205 Wiesbaden, Germany

Tel: +49 611 973040 Fax: +49 611 97304600
taylor-hobson.germany@ametek.com



Taylor Hobson India

1st Floor, Prestige Featherlite Tech Park
148, EPIP II Phase, Whitefield, Bangalore – 560 006
Tel: +91 1860 2662 468 Fax: +91 80 6782 3232
taylor-hobson.india@ametek.com



Taylor Hobson Italy

Via De Barzi
20087 Robecco sul Naviglio, Milan, Italy

Tel: +39 02 946 93401 Fax: +39 02 946 93450
taylor-hobson.italy@ametek.com



Taylor Hobson Japan

3F Shiba NBF Tower, 1-1-30, Shiba Daimon Minato-ku
Tokyo 105-0012, Japan

Tel: +81 (0) 3 6809-2406 Fax: +81 (0) 3 6809-2410
taylor-hobson.japan@ametek.com



Taylor Hobson Korea

#310, Gyeonggi R&DB Center, 906-5, Iui-dong
Yeongtong-gu, Suwon, Gyeonggi, 443-766, Korea
Tel: +82 31 888 5255 Fax: +82 31 888 5256
taylor-hobson.korea@ametek.com



Taylor Hobson China Beijing Office

Western Section, 2nd Floor, Jing Dong Fang Building (B10)
No.10, Jiu Xian Qiao Road, Chaoyang District, Beijing, 100015, China
Tel: +86 10 8526 2111 Fax: +86 10 8526 2141
taylor-hobson-china.sales@ametek.com.cn



Taylor Hobson China Shanghai Office

Part A1, A4, 2nd Floor, Building No. 1, No. 526 Fute 3rd Road East,
Pilot Free Trade Zone, Shanghai, China 200131
Tel: +86 21 5868 5111-110 Fax: +86 21 5866 0969-110
taylor-hobson-china.sales@ametek.com.cn



Taylor Hobson Singapore

AMETEK Singapore, 10 Ang Mo Kio Street 65
No. 05-12 Techpoint, Singapore 569059
Tel: +65 6484 2388 Ext 120 Fax: +65 6484 2388 Ext 120
taylor-hobson.singapore@ametek.com



Taylor Hobson USA

1725 Western Drive
West Chicago, Illinois 60185, USA
Tel: +1 630 621 3099 Fax: +1 630 231 1739
taylor-hobson.usa@ametek.com



www.taylor-hobson.com